



Válvulas de bola tres vías 'Security'

SALIDA ENCOLAR

ITEM 849

REFERENCIA	DESCRIPCIÓN	Peso neto	Volumen (m ³)	Peso bruto	Unidades lote
111V003	VALVULA ENLACE 3 VIAS L S/ENCOLAR 32	0,67	0,04460	3,97	4
111V005	VALVULA ENLACE 3 VIAS L S/ENCOLAR 50	1,657	0,04460	5,1298	2
111V006	V. E. 3 VIAS L S/ENCOLAR 63	2,685	0,03129	7,06	2
111V007	VALVULA ENLACE 3 VIAS L S/ENCOLAR 75	4,881	0,03892	5,76	1
111V043	V. E. 3 VIAS T S/ENCOLAR 32	0,667	0,03129	3,8019	4
111V045	V. E. 3 VIAS T S/ENCOLAR 50	1,646	0,04460	5,142	2
111V046	V. E. 3 VIAS T S/ENCOLAR 63	2,8031	0,04460	7,001	2
111V047	VALVULA ENLACE 3 VIAS T S/ENCOLAR 75	4,785	0,03892	5,67	1
111V744	V.ENLACE 3 VIAS L S/E 40	1,647	0,04460	5,14	2
111V748	V.ENLACE 3 VIAS L S/E 90	5,141	0,03892	6,02	1
111V754	V.ENLACE 3 VIAS T S/E 40	1,637	0,04460	5,12	2
111V758	V.ENLACE 3 VIAS T S/E 90	5,085	0,03892	6,117	1



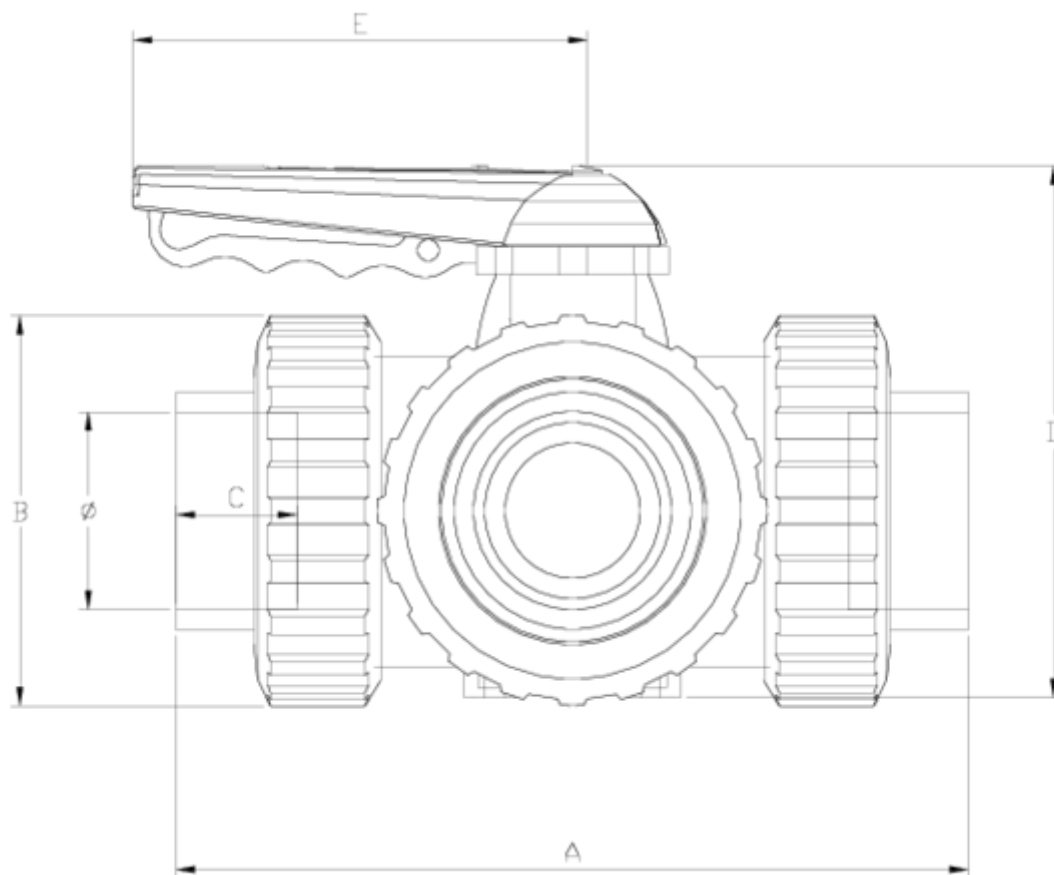

ITEM 849 | SALIDA ENCOLAR

PTFE	f	PESO (g)	DN	Modelo	A	B	C	D	E	PN	MEDIDA
11V003	32	712	25	L	160	72	22	121	114	PN16	MÉTRICO
11V744	40	1644	40	L	214	103	26	155	140	PN16	MÉTRICO
11V005	50	1653	40	L	216	103	31	155	140	PN16	MÉTRICO
11V006	63	2549	50	L	251	120	38	172	140	PN16	MÉTRICO
11V007	75	5008	65	L	308	150	45	218	160	PN10	MÉTRICO
11V748	90	5317	65	L	332	150	51	218	160	PN10	MÉTRICO
11V013	32	708	25	T	160	72	22	121	114	PN16	MÉTRICO
11V754	40	1634	40	T	214	103	26	155	140	PN16	MÉTRICO
11V045	50	1643	40	T	216	103	31	155	140	PN16	MÉTRICO
11V046	63	2531	50	T	251	120	38	172	140	PN16	MÉTRICO



ITEM 849 | SALIDA ENCOLAR

11V047	75	4968	65	T	308	150	45	218	160	PN10	MÉTRICO
11V758	90	5277	65	T	332	150	51	218	160	PN10	MÉTRICO



Documentación de Producto



Certificados de Producto

Certificados de Empresa

