



Vannes à boisseau 3 voies 'Security'

SORTIE TARAUDÉE

ITEM 850

RÉFÉRENCE	DESCRIPTION	Poids net	Volume (m ³)	Poids brut	Unités par lot
111V013	VÁLVULA BOLA 3 VÍAS MODELO "L" S/R/H 1"	0,681	0,03129	3,8579	4
111V015	VÁLVULA BOLA 3 VÍAS MODELO "L" S/R/H 1 1/2"	1,698	0,04460	5,25	2
111V016	VÁLVULA BOLA 3 VÍAS MODELO "L" S/R/H 2"	3,212	0,04460	7,154	2
111V017	VÁLVULA BOLA 3 VÍAS MODELO "L" S/R/H 2 1/2"	4,956	0,03892	5,83	1
111V053	VÁLVULA BOLA 3 VÍAS MODELO "T" S/R/H 1"	0,678	0,03129	3,8459	4
111V055	VÁLVULA BOLA 3 VÍAS MODELO "T" S/R/H 1 1/2"	1,7621	0,04460	5,34	2
111V056	VÁLVULA BOLA 3 VÍAS MODELO "T" S/R/H 2"	2,6151	0,04460	7,046	2
111V057	VÁLVULA BOLA 3 VÍAS MODELO "T" S/R/H 2 1/2"	5,1114	0,03892	5,99	1



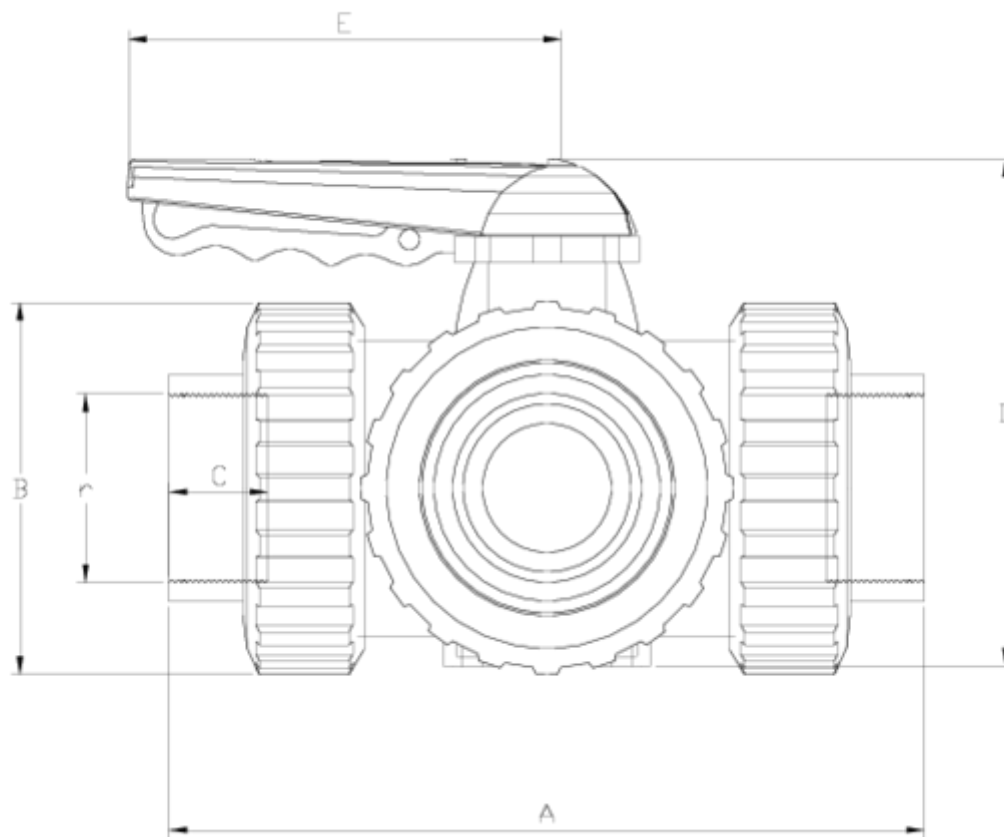

ITEM 850 | SORTIE TARAUDÉE

PTFE	r	PESO (g)	DN	Modelo	A	B	C	D	E	PN	TIPO ROSCA
11V013	1"	736	25	L	162	72	23	121	114	PN16	BSP
11V015	1 1/2"	1731	40	L	210	103	33	155	140	PN16	BSP
11V016	2"	2618	50	L	261	120	29	172	140	PN16	BSP
11V017	2 1/2"	5113	65	L	322	150	33	218	160	PN10	BSP
11V053	1"	732	25	T	162	72	23	121	114	PN16	BSP
11V055	1 1/2"	1721	40	T	210	103	33	155	140	PN16	BSP
11V056	2"	2600	50	T	261	120	29	172	140	PN16	BSP
11V057	2 1/2"	5073	65	T	322	150	33	218	160	PN10	BSP





Documentation Produit



Certifications de produits

Certificats d'entreprise

