



## Vannes boisseau 'compact'

# Sortie PE

## ITEM 568

RÉFÉRENCE	DESCRIPTION	Poids net	Volume (m <sup>3</sup> )	Poids brut	Unités par lot
111C020	VALVULA COMPACT PE 20	0,14963	0,00892	3,23	20
111C021	VALVULA COMPACT PE 25	0,19667	0,01553	4,26	20
111C022	VALVULA COMPACT PE 32	0,29672	0,01553	4,815	15
111C023	VALVULA COMPACT PE 40	0,444067	0,03129	7,234	15
111C024	VALVULA COMPACT PE 50	0,6793	0,03648	7,523	10
111C025	VALVULA COMPACT PE 63	1,28462	0,03100	6,78	5



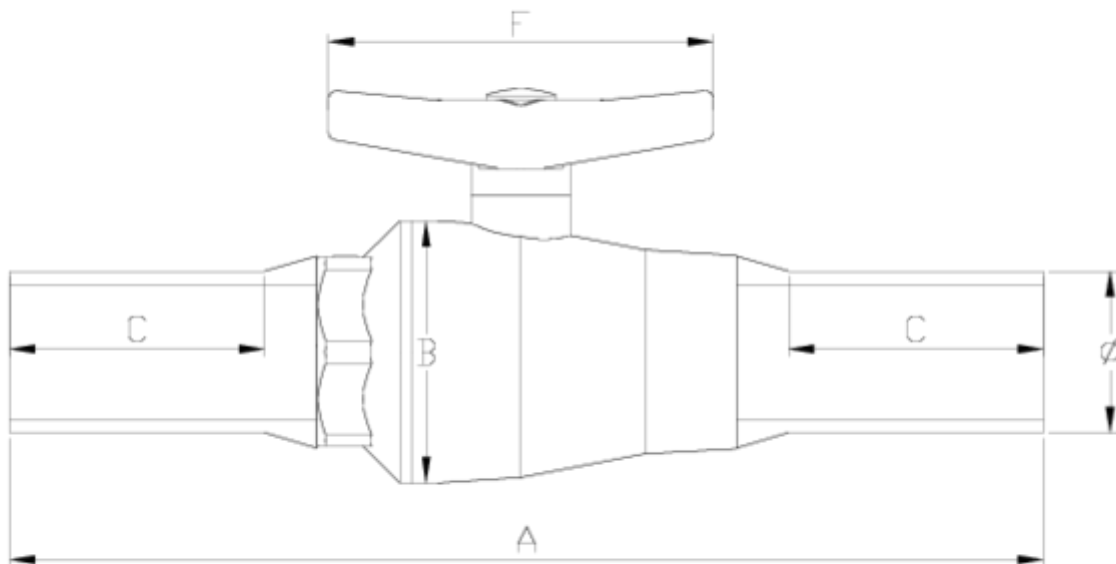

## ITEM 568 | Sortie PE

CÓDIGO	d	DN	PESO (g)	A	B	C	F	PN	MEDIDA
11C020	20	15	150	250	48	65	80	PN10	MÉTRICO
11C021	25	20	163	266	53	65	80	PN10	MÉTRICO
11C022	32	25	297	292	60	73	101	PN10	MÉTRICO
11C023	40	32	444	324	74	81	130	PN10	MÉTRICO
11C024	50	40	679	341	87	80	130	PN10	MÉTRICO
11C025	63	50	1095	389	104	89	150	PN10	MÉTRICO





## Documentation Produit



## Certifications de produits

## Certificats d'entreprise

