



Válvulas de esfera 3 vías "Security"

Válv. de bola 3 vías "Security" salida termofusión ITEM 852

REFERÊNCIA	DESCRIÇÃO	Peso líquido	Volume (m ³)	Peso bruto	Unidades por lote
111V033	VALVULA União 3 VIAS L S/TERMO 32	0	0,04460	0	4
111V035	VALVULA União 3 VIAS L S/TERMO 50	1,6715	0,04460	4,8129	2
111V036	VALVULA União 3 VIAS L S/TERMO 63	2,5204	0,04460	6,5107	2
111V037	VALVULA União 3 VIAS L S/TERMO 75	4,9478	0,03648	6,0728	1
111V073	VALVULA União 3 VIAS T S/TERMO 32	0	0,04460	0	4
111V075	VALVULA União 3 VIAS T S/TERMO 50	1,6715	0,04460	4,8129	2
111V076	VALVULA União 3 VIAS T S/TERMO 63	2,5204	0,04460	6,5107	2
111V077	VALVULA União 3 VIAS T S/TERMO 75	4,9478	0,03648	6,0728	1
111V098	VALVULA União 3 VIAS L S/TERMO 90	5,406	0,03892	6,2846	1
111V188	V.ENL 3 VIAS T S/TERMO 90	5,351	0,04460	6,41	1



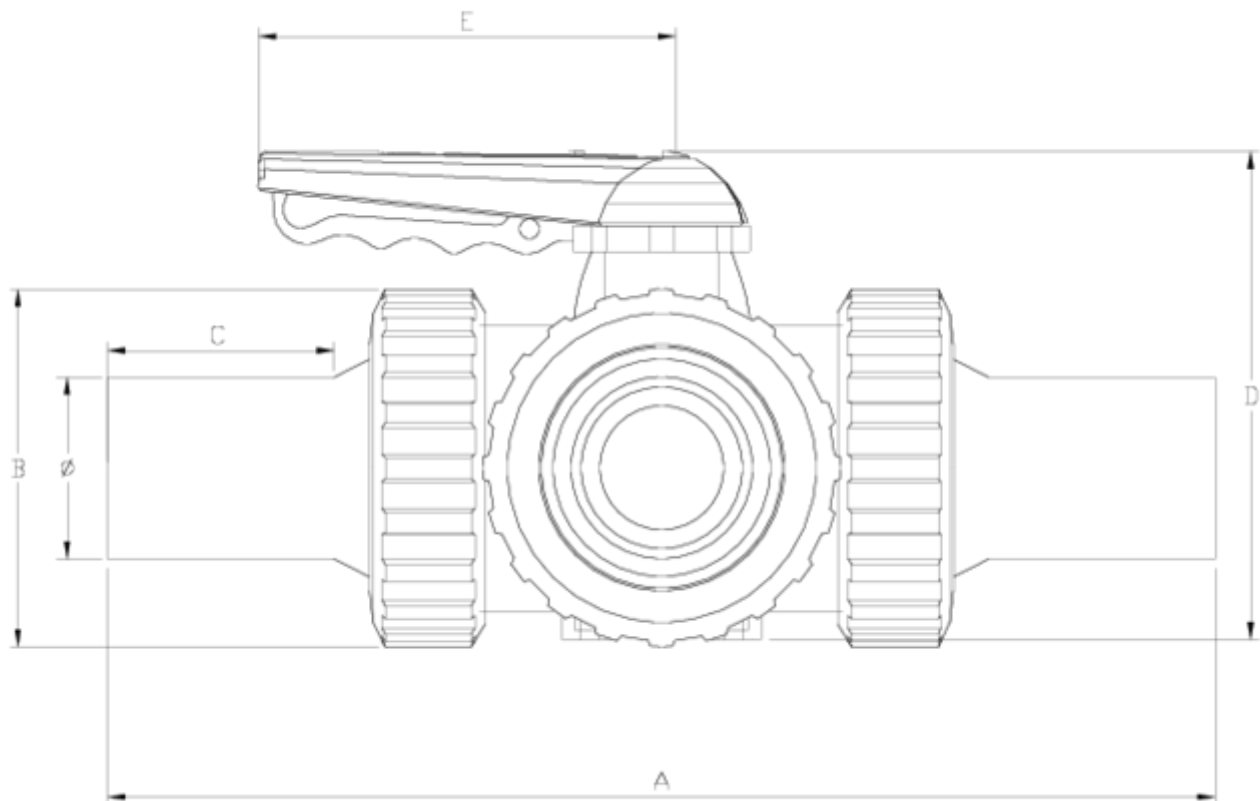

ITEM 852 | Válv. de bola 3 vías “Security” salida termofusión

PTFE	f	PESO (g)	DN	Modelo	A	B	C	D	E	PN	MEDIDA
11V033	32	736	25	L	262	72	70	121	114	PN16	MÉTRICO
11V035	50	1707	40	L	356	103	79	155	140	PN16	MÉTRICO
11V036	63	2663	50	L	401	120	89	172	140	PN16	MÉTRICO
11V037	75	5053	65	L	452	150	95	218	160	PN10	MÉTRICO
11V098	90	=C6+330	65	L	460	150	99	218	160	PN10	MÉTRICO
11V073	32	732	25	T	262	72	70	121	114	PN16	MÉTRICO
11V075	50	1697	40	T	356	103	79	155	140	PN16	MÉTRICO
11V076	63	2645	50	T	401	120	89	172	140	PN16	MÉTRICO
11V077	75	5013	65	T	452	150	95	218	160	PN10	MÉTRICO
11V188	90	=C11+330	65	T	460	150	99	218	160	PN10	MÉTRICO





ITEM 852 | Válv. de bola 3 vías “Security” salida termofusión





Documentação do Produto



Certificados do Produto

Certificados da Empresa

